

INSTRUCTIONS
for
UNI-DIRECTIONAL MICROPHONE
TYPE 77-A
(MI-4040)

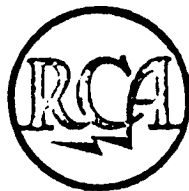

RCA Victor Division
RCA Manufacturing Company, Inc.
Camden, N. J., U. S. A.

OPERATING INSTRUCTIONS

FOR

UNI-DIRECTIONAL MICROPHONE

TYPE 77-A

(MI-4040)

PART I—DESCRIPTION

1. Introduction.—The RCA Type 77-A uni-directional microphone is an entirely new type of sound pick-up device—a microphone with a directional pick-up pattern wholly different from that of any other microphone. While it resembles the velocity microphone in appearance and construction, and is, in fact, evolved from research and development work on the latter, the RCA Type 77-A uni-directional microphone combines the principles of velocity and pressure operation. For this reason, it possesses in a surprising degree the best features of each and overcomes the disadvantages inherent in both. In view of the fact that the unit is designed to pick up sound arriving from one direction—or, more accurately, from one side—while almost completely rejecting sound from the other side, it is admirably adapted to studio pick-up, public address and sound reenforcement applications.

Instead of a diaphragm (in the commonly accepted meaning of the word), the uni-directional microphone contains a thin metallic ribbon suspended between the poles of a permanent magnet with its length perpendicular to, and its width in the plane of, the magnetic lines of force. The ribbon is rigidly clamped at the center, as well as at the top and the bottom. The lower half is open front and back and operated as a regular velocity microphone. In order to make the upper half of the ribbon operate as a pressure microphone, it is, of course, necessary that the rear of this section of the ribbon be enclosed. At the same time it is not possible just to block this section off, as such a contrivance would result in a response increasing with the frequency. Rather, it is necessary to present an acoustic impedance to the back part of the ribbon. An infinitely long tube would be the ideal impedance; but this, of course, is impossible. Instead, an ingenious labyrinth, which gives practically the same effect, is used. While this labyrinth has a finite length, the desired damping of reflection is obtained by filling it very loosely with sound-absorbing material. The result is that the upper half of the ribbon becomes an efficient pressure-operated microphone.

The vibration of each part of the ribbon is in exact accordance with the sound vibrations and, occurring as it does within the magnetic field, sets up corresponding alternating electric potentials across the primary of its associated transformer. Since the two microphones (*i. e.*, the velocity-operated section and the pressure-operated section of the Type 77-A microphone) are a part of the same ribbon, the voltages developed in the two sections are, of course, in series, and the output level is

obtained from the ends of the ribbon in essentially the same manner as in the case of the velocity microphone.

2. Description.—The uni-directional microphone shown in Figure 1 consists of a microphone unit mounted in a horizontal swivel on the top of a program stand. "Aiming" is accomplished partially by means of this swivel and partially by rotating the vertical column of the program stand. The transmitter is enclosed within a circular, perforated metal casing, so designed as to conform to the circular construction of the labyrinth, which occupies the lower part of the unit.

The labyrinth consists of a series of circular sections, the interior of each section having a spiral partition, an opening at the beginning or the end of which communicates with the beginning or the end, respectively, of the section of the labyrinth that immediately precedes or immediately follows it. The sections occupying the upper part of the labyrinth are so designed as to provide a cavity to accommodate the line coupling transformer, which thus forms a part of the microphone unit.

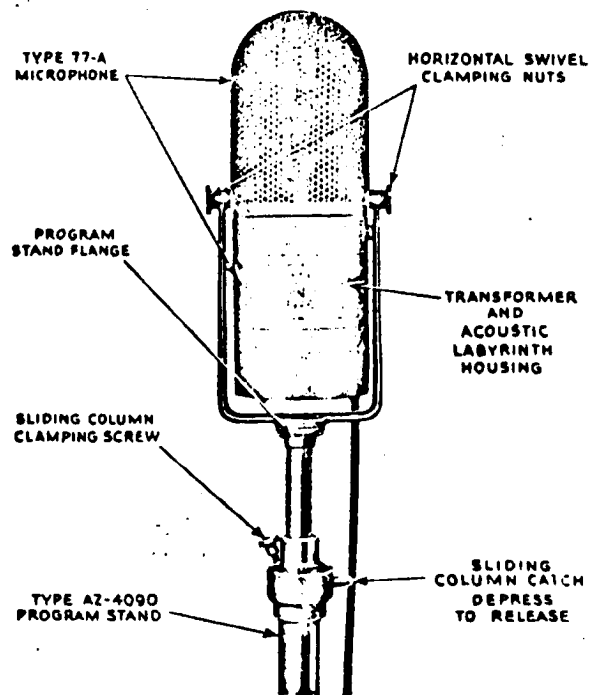

Figure 1—Close-up of Microphone on Program Stand

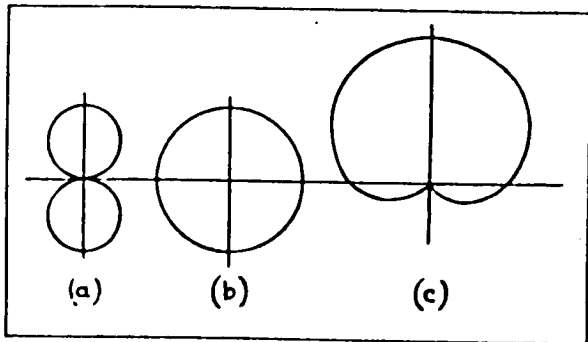

Figure 2—Development of Directional Pattern

The Type 77-A microphone unit is supported in a mounting yoke (containing the aforementioned horizontal swivel), which permits it to be tilted as desired. This mounting yoke is supplied with a threaded stand flange to fit a standard Type AZ-4090 program type microphone stand. A suspension mounting (Type UP-4212-A) is supplied to permit the suspension of the unit overhead when desired.

The microphone program stand (Type AZ-4090) is of the adjustable single vertical column type with a three-point base. The height of the transmitter may be adjusted to maximum and minimum heights of 84 inches and 59 inches respectively.

3. Sensitivity.—With an input sound pressure of 10 dynes per square centimeter perpendicular to the plane of the ribbon, the Type 77-A uni-directional microphone will deliver 317 microvolts across a 250-ohm load, which is equivalent to an output level of -75 db. as compared with a zero level of 12.5 milliwatts, or -72 db. as compared with a zero level of 6 milliwatts.

On an open circuit basis of measurement, *i. e.*, with an input of 1 dyne per square centimeter (1 bar) perpendicular to the ribbon, the output of the microphone on open circuit is the equivalent of -89 db. with reference to a zero level of 12.5 milliwatts.

4. Quality of Response.—The operating range of the microphone extends from 60 cycles to 10,000 cycles. When the microphone is located less than 2 feet from the source of sound the low frequency response is increased somewhat, and when operated at a greater distance (up to 4 feet) the low frequency response is slightly attenuated. Beyond the 4-foot operating distance the response characteristic is unchanged by changes in the operating distance. The frequency response is essentially unchanged by the direction of the incident sound over an angle of 150 degrees at the front of the microphone.

5. Directional Characteristics.—One of the most important characteristics of the Type 77-A microphone is its uni-directional property. On the front, or operating side, of the microphone the response is very uniform, while at the rear of the microphone sounds are attenuated an average of 20 db., thus giving a 10-to-1

ratio of desired to undesired pick-up. Sound waves originating in front and along an axis perpendicular to the plane of the ribbon will, naturally, have the maximum effect.

The outstanding advantage of the Type 77-A microphone is derived from the fact that the unit combines the action of a velocity-operated and a pressure-operated microphone and results from the manner in which the velocity-operated and the pressure-operated parts of the ribbon add together.

Without going into mathematical expressions for these voltages, it is possible to obtain a picture of the action from a consideration of the three patterns shown in Figure 2. In this illustration (a) is the directional pattern of a velocity microphone, (b) is the directional pattern of a pressure microphone. While these figures are the theoretical or idealized patterns, they correspond, for ribbon microphones, quite closely to actual measured characteristics.

When these patterns are added, the forward lobe of the figure-8 pattern adds to the circular pattern, while the rear lobe, which is 180 degrees out of phase, opposes. The result is the same as that obtained when the signals of a vertical antenna and a loop antenna are added; *viz.*, a cardioid of revolution, as shown at (c). In practice, the actual measured response of the Type 77-A uni-directional microphone, as shown in Figure 3, approaches this cardioid very closely. For all frequencies up to 6,000 cycles the cancellation is very good. At higher frequencies a small "tail" occurs because of the slight phase displacement that begins to become noticeable in this range.

It is at once apparent that the uni-directional characteristic is of considerable value in the solution of some of the difficulties encountered in reverberant locations by the reduction of the effect of undesired sound reflections, and the increased possibilities of obtaining better balance, clarity, naturalness and selectivity in sound pick-up. Extraneous direct or reflected sounds approaching the microphone from side directions and from the rear will have little or no effect and there-

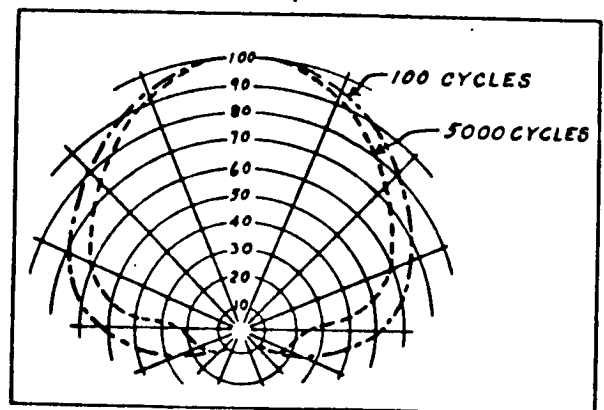

Figure 3—Cardioid Pattern of Microphone

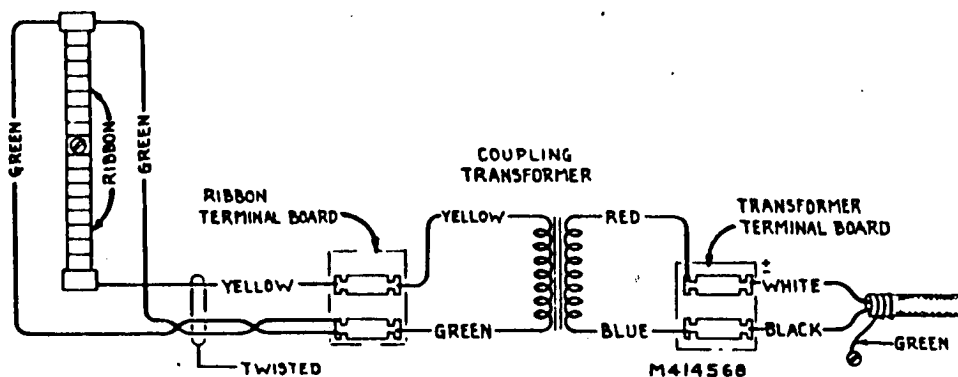

Figure 4—Schematic Wiring Diagram of Microphone

fore background noises and reflected sounds in the broadcast are considerably reduced, which increases, by comparison, the quality of direct sounds reproduced. The amount of sound-proofing necessary for sound originating within the "dead zone" can be greatly reduced—and, in many cases, "dead end" construction can be entirely eliminated.

For the same allowable reverberation pick-up the operating range of the uni-directional microphone is approximately 1.73 times greater than a non-directional microphone having the same sensitivity.

When used for public address and sound reinforcement purposes the directional characteristic is of considerable value in reducing feed-back effects between the microphone and the loudspeaker.

Sound concentrators and baffles used with condenser microphones are unnecessary with and inapplicable to the uni-directional microphone because of the fundamental difference in the principle of its operation. The transmitter must be used in free space where the flow of air particles is unimpeded. "Pick-up" from the rear of the microphone is eliminated by the design and construction of the unit.

PART II — OPERATION

6. **Microphone Assembly.**—The Type 77-A uni-directional microphone is shipped with the stand flange attached by means of three screws to the microphone mounting yoke. The suspension fitting is shipped in an envelope in the box with the microphone unit.

(a) **Stand Mounting.**—If it is desired to mount the microphone unit on a program stand, it is necessary merely to screw the microphone (using the stand flange) securely to the stand column. See Section 9, List of Parts and Accessories, for the type of stand recommended for this purpose.

(b) **Suspension Mounting.**—If it is desired to suspend the microphone overhead, the stand flange must be removed from the microphone mounting yoke and replaced with the suspension fitting, which contains the eyelets for cord attachment. The fitting must be attached securely to the yoke by means of the three screws formerly used for mounting the stand flange.

NOTE.—When the microphone is suspended see that its weight is carried on the suspension fitting, with no strain on the cable.

(c) **Cable Connections.**—The microphone is shipped with the microphone cable already connected at the microphone terminal board. This terminal board is rendered accessible for inspection or service by taking out the three screws located about the microphone screen mounting flange and removing the screen.

(d) **Phasing.**—When more than one microphone is used in a single pick-up, it is possible that the output of the various microphone circuits may not be in phase when fed into a common circuit. The microphone circuits include the microphones themselves, microphone pre-amplifiers, microphone attenuators (mixers) and the necessary connecting lines. The output of the microphone attenuators (mixers) when fed into the overall attenuator (mixer) must be in phase, or varying degrees of distortion will result, depending on the relative placement of the microphones. If two microphones are placed close together, the result will be practically zero output if their circuits are out of phase at the overall mixer.

To check the phasing of two or more microphones connected in a single pick-up, place the units close together, two at a time, with the attenuators (mixers) turned to the off position. Turn on the attenuator of one microphone to some arbitrary position where the output will be distinctly audible or register definitely on the volume indicator meter, if such a device is used. Talk into the microphone and note the output volume. Now, without disturbing the setting of the attenuator of the microphone just used, turn on the attenuator of the second microphone to the same setting. Talk into the two microphones and note the result. If there is an increase in volume, the microphones are in phase. If there is a decrease in volume, remove the screen of one microphone and reverse the connections at the microphone cable terminal board. If more than two microphones are employed, using one microphone as a reference, check the other units against it, one at a time, in the manner outlined above. If any are found to be out of phase, reverse the cable connections, at the

microphone cable terminal board, of the lesser number of microphones necessary to bring all the units into phase. A thirty-foot cable is furnished as part of the microphone equipment. The microphone plug must be furnished by the customer. For microphone connections refer to Figure 4, Schematic Wiring Diagram.

7. Technique of Uni-Directional Microphone Placement.—The proper placement of the microphone is essential in order to realize fully its inherent advantages. For this reason, the following instructions should be carefully studied, and close attention should be given to the results of any special placement, with a view toward future improvement of technique. These instructions can, of course, serve only as a guide, and a study should be made to determine the best microphone placement for each condition.

(a) General.—The Type 77-A uni-directional microphone has a pick-up angle of approximately 150 degrees. The source of sound, speaker, announcer, actor or musical instrument, should not be placed closer to the microphone than 2 feet, and a distance of from 3 to 4 feet is to be preferred. At shorter distances there is a tendency toward accentuation of low frequencies, which may result in making voices sound "boomy." In this respect the use of the uni-directional microphone differs greatly from that of the condenser microphone, with which the soloist usually works at a distance of from 4 to 6 inches. As a point of useful information, it may be mentioned here that the uni-directional microphone may be used as a close-talking microphone by talking in the plane of the ribbon. In this position, only the pressure-operated part of the ribbon is used.

The placement of a speaker or musical instrument off from the center line of the microphone will in no way affect the quality of pick-up, but will merely attenuate the direct sound pick-up, thereby raising the ratio of reverberation to direct pick-up.

The microphone is uni-directional. Speakers, instruments or players may be placed on the operating side of the microphone only. The diagrams (Figures 5, 6, 7 and 9) will serve as examples which arise from the uni-directional characteristic.

For most satisfactory results, the microphone should not be placed closer than 3 feet to any solid reflecting surface. This statement is, of course, general and specific conditions may require otherwise.

The diagrams referred to in the subsequent paragraphs and the discussion concerning them can only serve to indicate some of the possible placements under particular conditions. The final decision as to what constitutes the proper placement must rest with someone who is competent to judge the quality of the results as reproduced by the monitor speaker.

(b) Soloist with Piano.—Interesting effects may be obtained by changing the angle of the microphone with respect to the piano, thus changing the ratio of reverberation to direct pick-up. The distance between the soloist and the microphone should be determined by the strength of his (or her) voice, and the piano should be placed accordingly. The general arrangement is shown in Figure 5. Under no condition should the soloist be less than 2 feet from the microphone.

(c) Stage Plays.—In the case of stage plays and those pick-ups of the type that occur in the case of auditorium-type studios, where a sizable audience is present—and in remote pick-ups at theatres, night clubs and the like, where audience noise presents a serious problem, the use of the uni-directional microphone possesses a distinct advantage. By placing the microphone with its dead-side toward the audience and close to the footlights, or in an equivalent position, the 20 db. discrimination will provide the desired attenuation of audience noise, while the broad pick-up angle—useful through nearly 150 degrees—will afford pick-up of the whole stage, or that part of the studio where the artists are located. See Figure 6.

(d) Dance Orchestra.—The set-up for dance orchestra is similar to that just outlined for stage plays, the dead-side of the uni-directional microphone being toward the dance floor. The diagram (Figure 7) is self-explanatory, the only precaution necessary being to keep the soloist at least 2 feet, and preferably 3 feet, from the microphone.

In locating the microphone with respect to an orchestra, care should be taken to avoid reflected pick-up

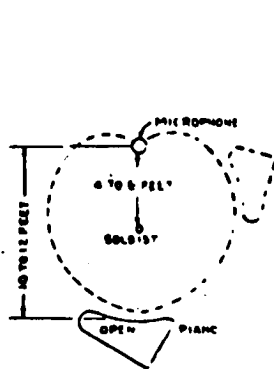

Figure 5—Soloist with Piano

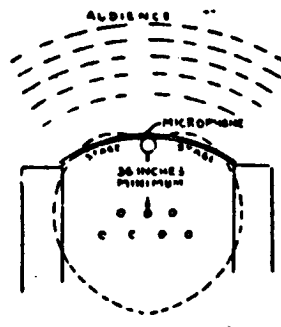

Figure 6—Plays

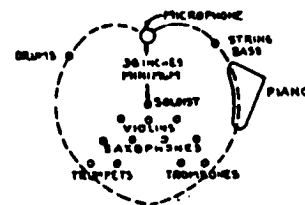

Figure 7—Dance Orchestra

VARIOUS MICROPHONE ARRANGEMENTS

from hard surfaced floors. Such reflections can be avoided by the use of carpets or similar material on the floor.

(c) *Large Orchestra.* An arrangement for a large symphony orchestra is shown in Figure 9. It is to be noted that the wide angle of coverage (150 degrees) of the uni-directional microphone will permit a satisfactory pick-up in many cases, such as that shown, with but one microphone. It must be borne in mind, however, that the physical proportions and acoustic properties of the studio have a direct bearing on the arrangement of the orchestra and the placement of the microphone. Where space considerations do not govern, changes from the arrangement shown should not necessarily be very extensive in order to give excellent results under the usual acoustic conditions.

(1) *Public Address.* For public address use the microphone can usually be placed near the loudspeakers (within 3 or 4 feet). It is important to see that the dead-side of the microphone is toward the loudspeaker system—more specifically, the microphone should not be placed in front or directly behind the loudspeakers to prevent acoustic feedback. If the speaker must have latitude of movement on the stage, it may be necessary to have a microphone installed at each side to obtain satisfactory pick-up.

(a) *Sound Reinforcing.* Microphones used for this purpose generally be concealed and may be successfully operated in the wings, flies, etc., or at the front of the stage, where some simple method may be devised for their concealment. Such a system usually requires the use of a number of microphones and their detailed location is largely determined by their exact use, the constructional details of the stage and other conditions so numerous as to preclude any definite statement of rules or methods of application. The uni-directional feature of the microphones may be utilized to great advantage in eliminating undesirable noise emanating from the audience area. It is also to be noted that, because of the wide pick-up angle of the uni-directional microphone, fewer units of this type than of any other will be required for proper coverage.

8. Operation. In general, the microphone will operate satisfactorily and require very little attention. It should give the normal output listed in Section 3.

The microphone may be suspended or it may be mounted on a program or floor stand. This stand is adjustable as to height. The center of the uni-directional microphone may be located at any height from 59 to 84 inches above the floor. In order to raise or lower the stand, the vertical column clamping screw should first be loosened. If it is desired to raise the microphone, all that is necessary is to lift it to the desired point and there it will lock itself automatically. Usually it will remain fixed at this position unless there is vibration or the microphone and stand are moved around. This moving may cause the stand to slide slowly downward. The clamping screw is provided in order to prevent this. However, if the microphone does not tend to creep, it is not necessary to use

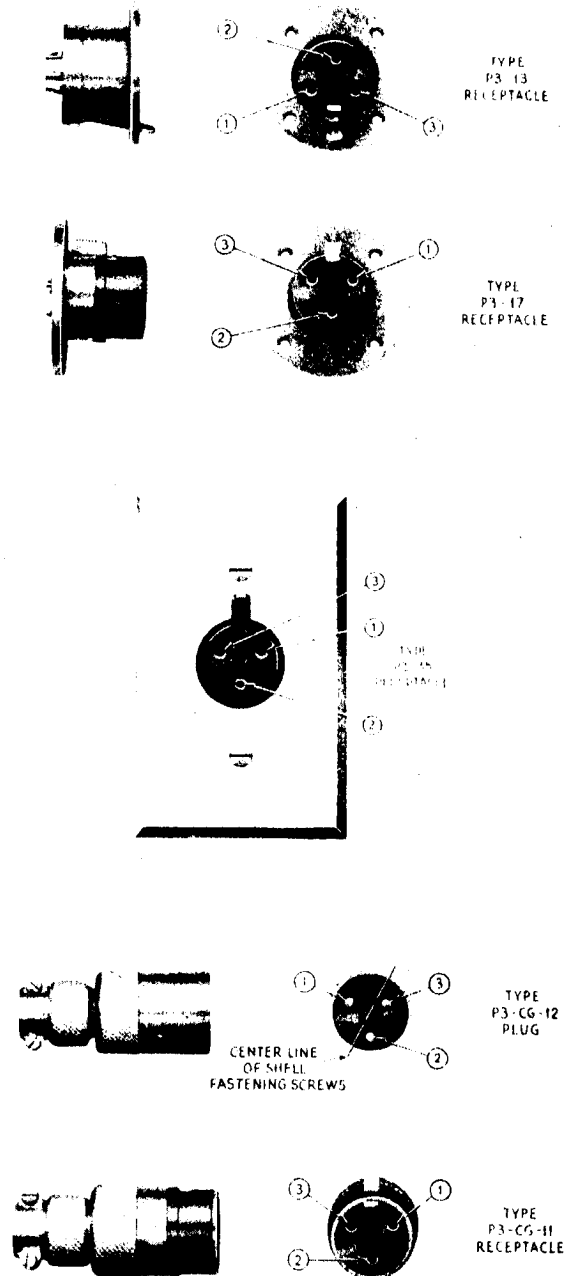
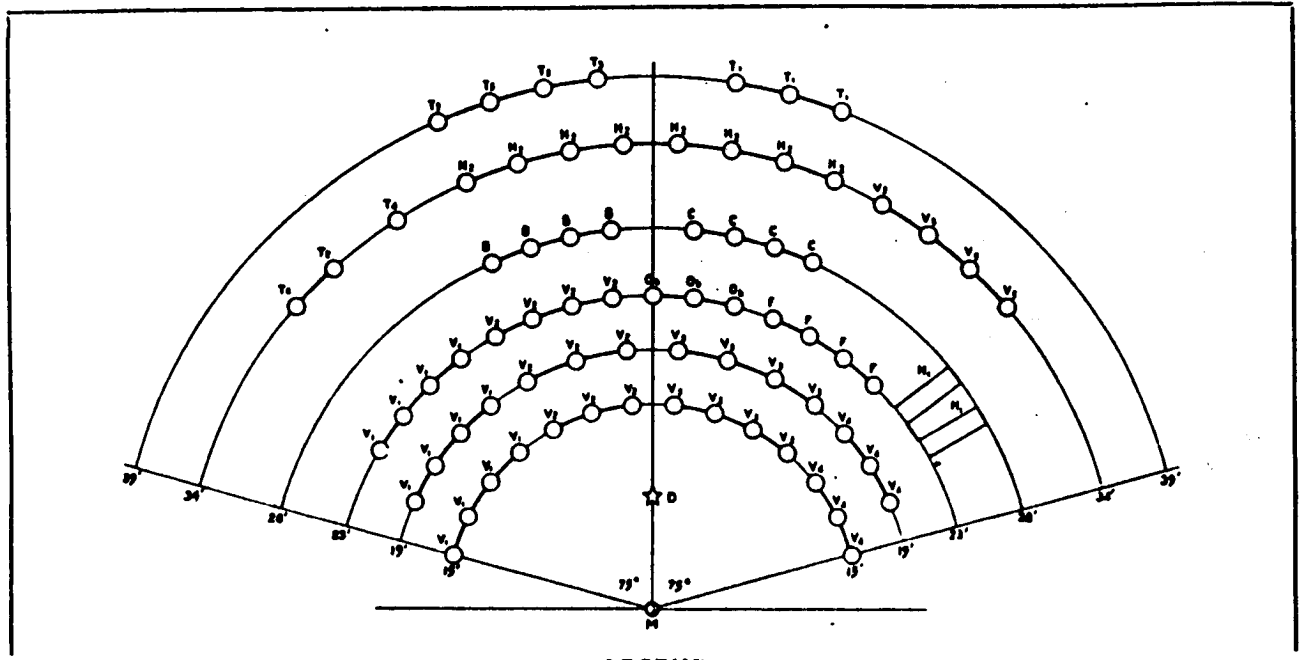

Figure 8—Plugs and Receptacles

the clamping screw. When it is desired to lower the microphone stand, the clamping screw should first be loosened, then the inner tube of the microphone stand should be raised slightly while pressing the sliding column latch which projects at the side of the locking device. This will release the lock and allow the microphone to be lowered to the desired position, at which point the latch should be released and the stand will



LEGEND

- | | | | |
|---------------|-------------------|------------------------|--------------------|
| D Director | F 4 Flutes | T2 2 Tympani and Traps | I1 8 Iolas |
| M Microphone | H1 2 Harps | T3 4 Trombones | I2 6 Cellos |
| | H2 8 French Horns | T4 1 Tuba | I3 4 String Bass |
| B 4 Bassoons | Ob 3 Oboes | V1 12 First Violins | |
| C 4 Clarinets | T1 3 Trumpets | V2 10 Second Violins | Total 75 Musicians |

Figure 9—Microphone and Orchestra Arrangement for Symphony Orchestra

automatically lock itself. Then the clamping screw may be tightened if desired.

It is not recommended that the customer attempt to repair the microphone, but, rather, that it be returned to the RCA Manufacturing Company, Inc., for repair.

This may be done by writing to the RCA Manufacturing Company, Inc., for a "RETURNED APPARATUS" tag and "REPORT BLANK." Before doing this, however, make absolutely certain that the trouble is in the microphone and not elsewhere in the circuit.

9. List of Parts and Accessories.—

Description	Type	Stock No.
Uni-Directional Microphone.....	77-A	MI-4040
Program Stand.....	AZ-4090	MI-4056
Suspension Fitting.....	UP-4212-A	MI-4071-A
Stand Flange.....		16857
Microphone Screen Assembly.....		16856
Swivel Clamping Nut.....		16478
Washer (used under Swivel Clamping Nut).....		16827
Microphone Cable.....		MI-62*
Microphone Plug.....	Cannon	MI-4630
	Type P3-CG-12	
Female Cord Connector.....	Cannon	MI-4620
	Type P3-CG-11	
Flush Type Wall Receptacle.....	Cannon	MI-4622
	Type P3-13	
Surface Type Wall Receptacle.....	Cannon	MI-4621
	Type P3-17	
Flush Type Wall Receptacle.....	Cannon	MI-4625
	Type P3-35	

* Length of cable must be specified when ordering.